

**Technical features:**

- Powered latch-bolt, dead-bolt and extension bolts for automatic operation
- Automatic closing of the door
- Emergency opening with the mechanical key
- Steel case and cover
- Zinc plated high resistant steel dead-bolt
- Non-handed zinc plated high resistant anti-picking latch-bolt
- Anti-crush plates for fixing screws
- Steel extension bolts

**Supplied as standard:**

- 12V - 2.3 AH lead battery
- Connecting cables

**Finishes:**

- Zinc plated aluminium

**Standards:**

- Product in compliance with European Standard EN 12209:2003

**Hand:**

0 = Non-handed

**Cylinder to be ordered separately**



# CISA Evolution

Type	Description	DEAD-BOLTS								ITEM			
		No.	Projection	Centre distance	Throws	Centre Distance	Faceplate	Backset	Unit weight	Pieces	Type	Dim. Hand	Fin.

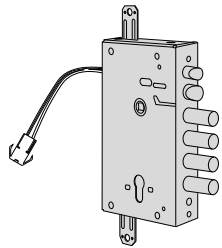

- Deadbolt and latchbolt
- Pre-arranged for additional locking points

4	3,5	27	85	64	3,320	1	1	E6515 27 0
4	3,5	28	85	64	4,800	1	1	E6515 28 0
3	3,5	38	85	64	3,320	1	1	E6515 38 0

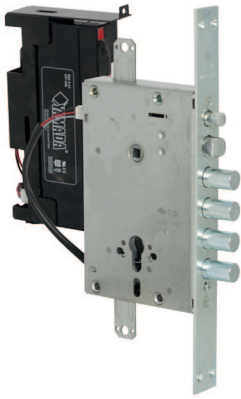

**Technical features:**

- Powered latch-bolt, dead-bolt and extension bolts for automatic operation
- Automatic closing of the door
- Emergency opening with the mechanical key
- Steel case and cover
- Zinc plated high resistant steel faceplated
- Zinc plated high resistant steel dead-bolt
- Non-handed zinc plated high resistant anti-picking latch-bolt
- Anti-crush plates for fixing screws
- Steel extension bolts

**Supplied as standard:**

- 12V - 2.3 AH lead battery
- Connecting cables

**Finishes:**

- Zinc plated aluminium

**Standards:**

- Product in compliance with European Standard EN 12209:2003

**Hand:**

0 = Non-handed

**Cylinder to be ordered separately**



# CISA Evolution

Type	Description	DEAD-BOLTS							Unit weight	Pieces	ITEM				
		No.	Projection	Centre Distance	Throws	Centre Distance	Faceplate	Backset			Kg		Type	Dim.	Hand
	<ul style="list-style-type: none"> <li>• Deadbolt and latchbolt</li> <li>• Pre-arranged for additional locking points</li> </ul>	4	28	85	35	67	5,300	1	1	E6535	28	0			

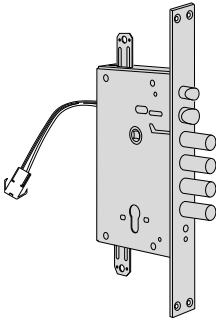

Type	Description	For series/item	L	Unit weight Kg	Pieces	ITEM			
						Type	Dim.	Hand	Fin.

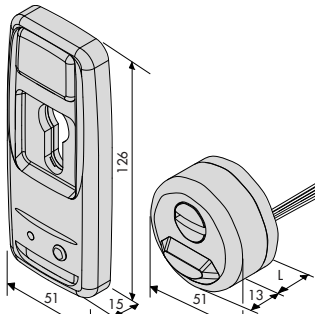

- Carbonitrided steel outside rose
- Electronic key reader
- Inside escutcheon with push-button
- 3 electronic keys
- Brass ring
- 2 screws L. 45 mm. (M6)
- AVAILABLE FINISHES:  
Polished brass (fin. 00)  
Polished chrome-plated (fin. 18)  
Gunbarrel grey (fin. 46)  
Anodized light bronze (fin. 64)  
Satin finished nickel-chrome plated (fin. B1)

0A310,0H3S0, 16,0 0,385 1 1 06525 00 0  
0L3S1,0M311

0A310,0H3S0, 24,5 0,385 1 1 06525 01 0  
0L3S1,0M311

0A310,0H3S0, 34,5 0,385 1 1 06525 02 0  
0L3S1,0M311

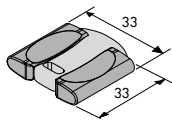

- Electronic key (Transponder)

0,085 1 1 06526 00 0

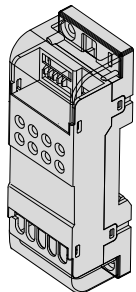

- Bticino interface modul may be combined with E-Volution series locks to make locks and My Home Bticino system communicate
- supplied as standard.  
Fixing screws  
instruction sheet

0,385 1 1 06527 00 0

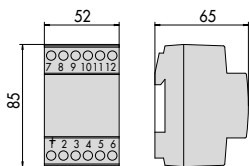

- 40 VA 12V ac transformer

0,492 1 1 07060 01 0